

EMLOCKS

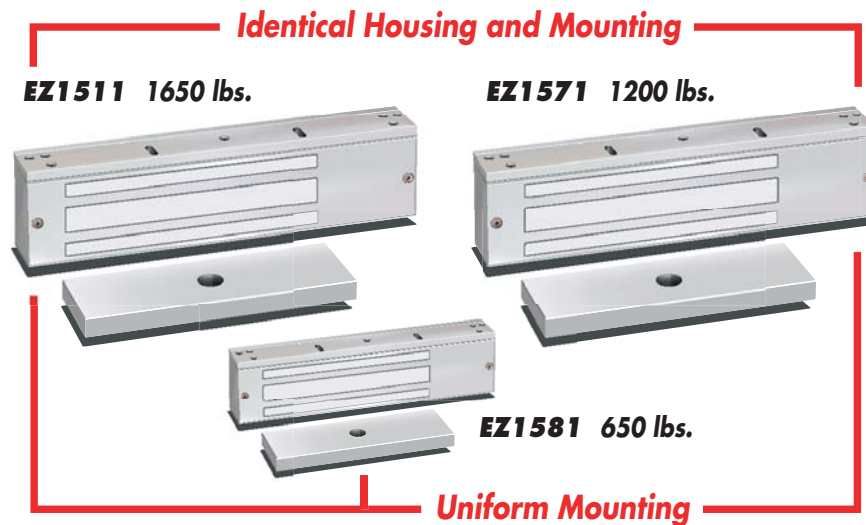

New EMLock Design

- Interchangeable & Upgradeable Modular Assemblies
- Uniform Design & Installation
- Identical Housing, Template & Accessories - *(1650 lb/1200 lb locks)
- Lifetime Serviceability
- EZ Mount Assembly

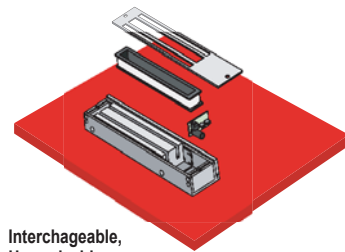

Interchangeable,
Upgradeable,
Modular Assemblies

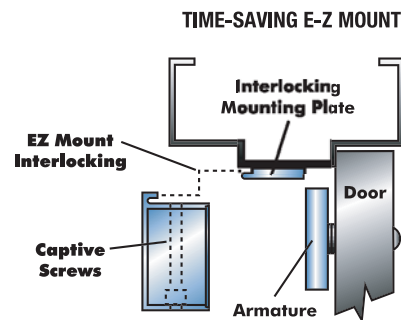

Request your FREE EMLock CD presentation online:

www.sdsecurity.com



ISO 9001-2000
FM 52705



CSFM
Listed

MEA
Listed



Manufacturers of Premium
Grade Access Hardware

Box 6219 • Westlake Village, CA 91359-6219
805.494.0622 FAX: 805.494.8861

Uniform Design and Installation of all Models



Distributor and Installer Flexibility

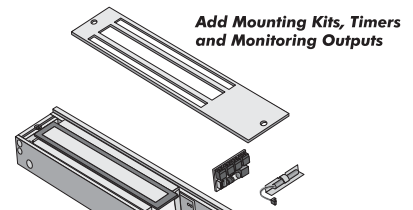

The modular design permits the addition of optional features, enabling standard locks to conform to several applications.

Lifetime Serviceability and Upgradeability

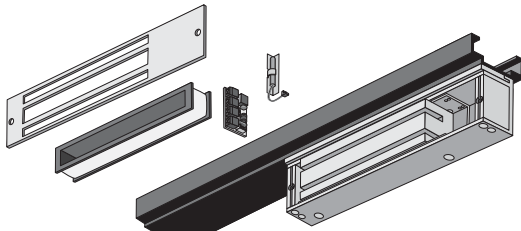

Upgrades and service without removing the lock from the frame eliminates lock replacement lead time and labor

Interlocking EZ Mount Assembly

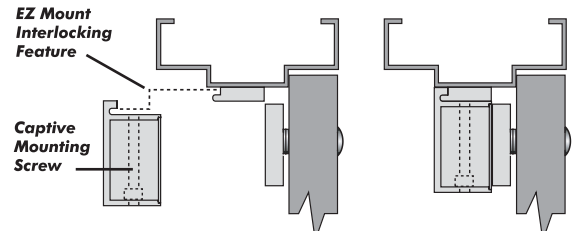

View the animated presentation and see how easy SDC EmLock installation is at www.sdcsecurity.com

Specifications

GK

1510 Series Grade 1
1650 lb / 748 Kg Holding Force





Electrical Specifications

Voltage: 12/24VDC Voltage Sensing Input
Single: 350mA @ 24VDC; 670mA @ 12VDC
Double: 700mA @ 24VDC; 1.34mA @ 12VDC

Mechanical Specifications

Single: 11" L x 2.75" H x 1.562" D
(279.4 x 69.9 x 39.7 mm)
Double: 22" L x 2.75" H x 1.562" D
(558.8 x 69.9 x 39.7 mm)

Common Configurations (Alum. Finish)

1511V	Single EmLock	
1511V-DPS	Door Sensor	
1511V-BA	Bond Sensor	
1511V-AT	Relock Timer	
1511V-BADPS	Door/Bond Sensor	
1511V-TJ1V	Top Jamb kit	
1511V-HDB1V	Glass Door kit	
1512V	Double EmLock	
1512V-2DPS	2 Door Sensor	
1512V-2BA	2 Bond Sensor	
1512V-AT	Timer	
1512V-TJ2V	Top Jamb kit	
1512V-HDB2V	Glass Door kit	

1570 Series Grade 2
1200 lb / 544 Kg Holding Force
Low Power Consumption





Electrical Specifications

Voltage: 12/24VDC Voltage Sensing Input
Single: 125mA @ 24VDC; 250mA @ 12VDC
Double: 250mA @ 24VDC; 500mA @ 12VDC

Mechanical Specifications

Single: 11" L x 2.75" H x 1.562" D
(279.4 x 69.9 x 39.7 mm)
Double: 22" L x 2.75" H x 1.562" D
(558.8 x 69.9 x 39.7 mm)

Common Configurations (Alum. Finish)

1571V	Single EmLock	
1571V-DPS	Door Sensor	
1571V-BA	Bond Sensor	
1571V-AT	Relock Timer	
1571V-BADPS	Door/Bond Sensor	
1571V-TJ1V	Top Jamb kit	
1571V-HDB1V	Glass Door kit	
1572V	Double EmLock	
1572V-2DPS	2 Door Sensor	
1572V-2BA	2 Bond Sensor	
1572V-AT	Timer	
1572V-TJ2V	Top Jamb kit	
1572V-HDB2V	Glass Door kit	

1580 Series Grade 3
650 lb / 295 Kg Holding Force



Electrical Specifications

Voltage: 12/24VDC Voltage Sensing Input
Single: 220mA @ 24VDC; 440mA @ 12VDC
Double: 440mA @ 24VDC; 880mA @ 12VDC

Mechanical Specifications

Single: 8.75" L x 2.125" H x 1.25" D
(222.2 x 54 x 31.8 mm)
Double: 17.5" L x 2.125" H x 1.25" D
(444.5 x 54 x 31.8 mm)

Common Configurations (Alum. Finish)

1581V	Single EmLock	
1581V-DPS	Door Sensor	
1581V-BA	Bond Sensor	
1581V-BADPS	Door/Bond Sensor	
1581V-TJ81V	Top Jamb kit	
1581V-HDB1V	Glass Door kit	
1582V	Double EmLock	
1582V-2DPS	2 Door Sensor	
1582V-2BA	2 Bond Sensor	
1582V-TJ82V	Top Jamb kit	
1582V-HDB2V	Glass Door kit	

Listings and Performance Specifications

GK

UL Listed U.S./Canada: GWXT Auxiliary Locks, CVXJ Burglary Resistant Electrically Operated Door Lock
UL10C Position Positive Pressure Compliant
ANSI/BHMA A156.23: 1510 - Grade 1; 1570 - Grade 2; 1580 Grade 3
BHMA Certified Holding Force: 1510 - Grade 1; 1570 - Grade 2; 1580 Grade 3

CSFM California State Fire Marshal Listed 3774-0324:100
MEA City of New York 61-95-E
UBC Classified in accordance with Uniform Building Code standard 7-2 "Fire Test for Door Assemblies"

1 EMLOCK MODELS **GK**

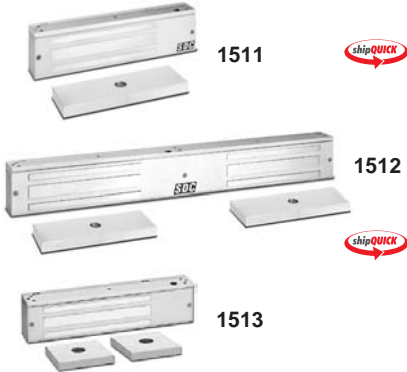

Grade 1
1650 lb / 748 Kg Holding Force

1511 Single Emlock
1512 Double Emlock
1513 Single Emlock, split armature for pair of doors



Grade 2
1200 lb / 544 Kg Holding Force

1571 Single Emlock
1572 Double Emlock
1573 Single Emlock, split armature for pair of doors



Grade 3
650 lb / 295 Kg Holding Force

1581 Single Emlock
1582 Double Emlock

2 FINISHES **GK**

Anodized Finishes
V 628 Aluminum (Standard) No Charge
X 313 Dark Bronze
Y 335 Black

Plated Finishes
C 605 Bright Brass G 612 Satin Bronze
D 606 Dark Bronze P 625 Bright Chrome
F 611 Bright Bronze Q 626 Satin Chrome

3 OPTIONAL INPUTS & OUTPUT **GK**

See Modular Program price list when ordering separately for field upgrades. Different part numbers and pricing apply.

- AT Adjustable Timer** - Built in field adj. 0-30 sec. relock delay. **Specify one for single or double EmLocks** (not available with 1580 series).
- DPS Door Position Sensor** - Indicates door open and door closed. SPDT Dry, 250 mA @ 30VDC. **Specify (2) for double EmLocks**
- BA Magnetic Bond Sensor** - Indicates locked with full holding power and unlocked, low holding power, low voltage, tampering and obstruction between armature and magnetic core. **Specify (2) for double EmLocks**
 - 1510 & 1570 Series: SPDT Dry, 250 mA @ 30VDC.
 - 1580 Series: SPST N.O., Dry, 250 mA @ 30VDC.
- L3 Tri-color status LED indicator** - Field selectable Red, Green, Amber.
 - Indicates lock energized when wired to lock input.
 - Indicates de-energized/unlocked or "Enter/Go" when wired to built-in TD Module
 - Indicates energized and de-energized or "Enter/Go" when wired to access control auxiliary output.
 - Indicates door is closed and locked and door is unlocked when wired to BA.
- ATS Anti-Tamper Sensor** - Indicates access cover removal. SPDT Dry, 1 Amp @ 30VDC



Over 100 SDC products are available for shipment the same day or by the next business day. End users and installers are encouraged to use the shipQUICK Inventory list so you know first hand which SDC products your SDC distributor can expedite for you. Request a shipQUICK Inventory through our customer service staff or download a copy directly from the SDC website.

SDC SECURITY DOOR CONTROLS
3580 Willow Lane • Westlake Village, CA 91361
www.sdcsecurity.com

4 TOP JAMB MOUNTING BRACKETS **GK**

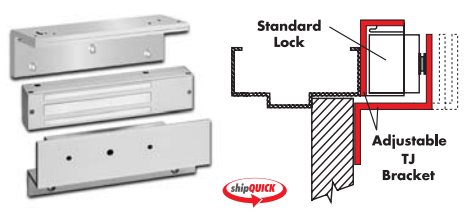

Kits for 1200 lb and 1650 lb locks
 TJ1 Single
 TJ2 Double

Special Anodized Finish: Single TJ
 Double TJ

Special Plated Finish: Single TJ
 Double TJ

Kits for 650 lb locks
 TJ81 Single
 TJ82 Double

TJ1V indicates standard aluminum

See page 20 Section **2** for special finish designation.

5 UNIVERSAL GLASS DOOR MOUNTING KIT **GK**

- Universal glass door kits are compatible with lock models, except 1513 and 1573
- Field adjustable for 1/2", 5/8" and 3/4" all glass Herculite doors

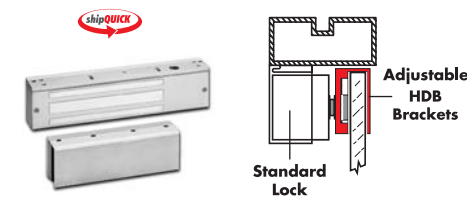

Kits for 1511, 1571, 1581
 HDB1 Single

Special Anodized Finish:

Special Plated Finish:

Aluminum Standard: Example - HDB1V
 See page 20 Section **2** for special finish designation.

Kits for 1512, 1572, 1582
 HDB2 Double, 2 single kits

Special Anodized Finish:

Special Plated Finish:

6 ARCHITECTURAL HOUSINGS **GK**

HORIZONTAL HOUSING			VERTICAL HOUSING		
1511	V	36	1512	V	V82

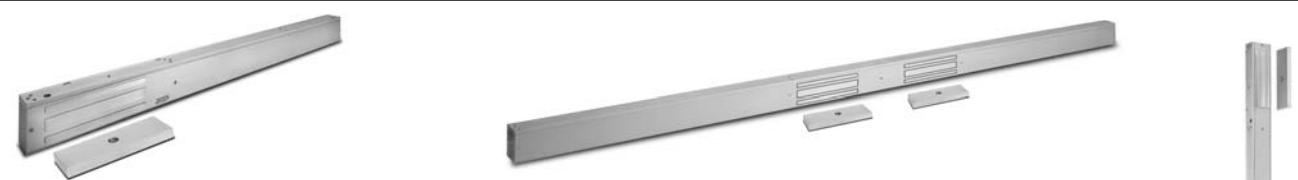

Full Width Housings - appear as part of the frame to provide a superior architectural appearance.
Vertical Housings - Side jamb mount, accommodates two 1571 or two 1511 EmLocks providing 2400 or 3300 lbs of holding force.
Compatible with Models: 1511, 1512, 1571, 1572 with or without HDB kits.
 Specify housings with your EmLocks.

Single Door Housings
 30 30"
 36 36"
 40 40"
 48 48"

Double Door Housings
 60 60"
 72 72"
 84 84"
 96 96"

Vertical Housings
 82 84" high opening

CV___ Custom, Specify Length

CH___ Custom, Specify Length

CH___ Custom, Specify Length

Aluminum Standard
 Example: 1511V30

Special Finishes
 See page 20 Section **2** for special finish designation and finish price.

UNIVERSAL HEADER BRACKET **GK**

Used in lieu of angle brackets, Universal Header Brackets provides a faster mounting solution, saving time and labor costs for several EmLock models. Reduce potential for mis-sized and misaligned mounting holes, broken taps, removal of broken taps. Combined with interlocking E-Z mount assembly, save up to a half days labor with the installation of 12 locks.

Features

- Solid 1" bar provides higher security and superior aesthetics.
- Machined wire chase provides concealed and secure wiring.
- Multiple predrilled and tapped mounting holes to accommodate the use of several different locks on either 4" or 4.5" aluminum frames

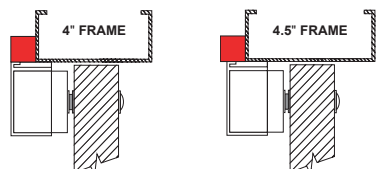

Bracket for 1511, 1513, 1571, 1573
 UB11 1" x 1" x 11"

Bracket for 1512, 1572
 UB12 1" x 1" x 22"

Aluminum Standard
 Example: UB1V

Special Finishes
 See page 22 for special finish designation

